

Инструкция по сборке АТ-30

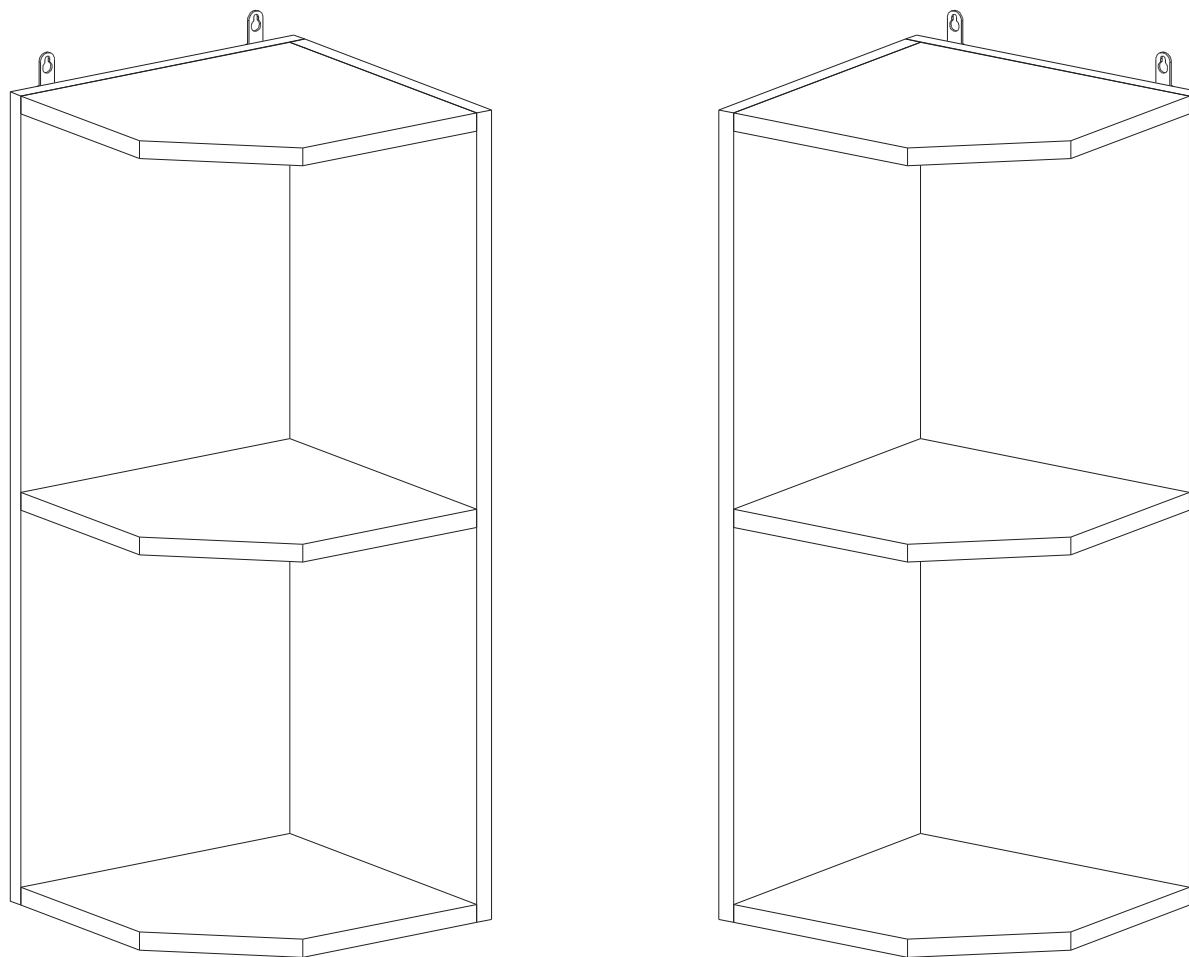

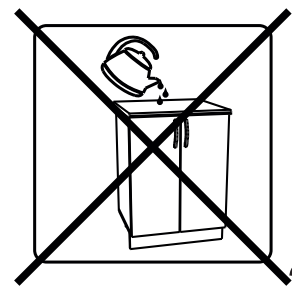
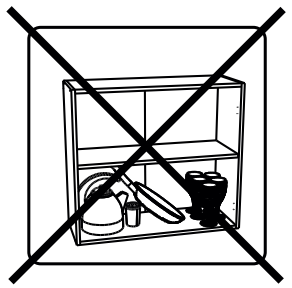
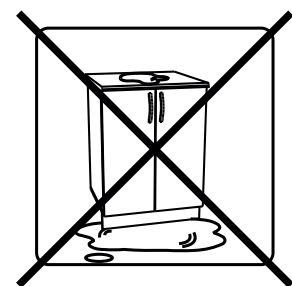
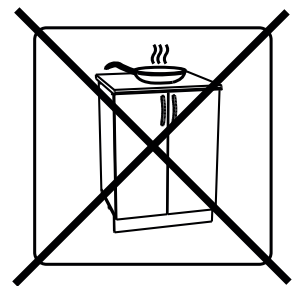
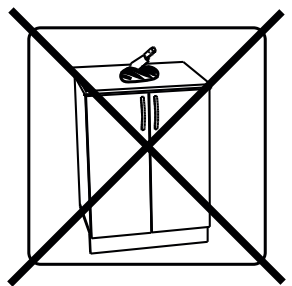
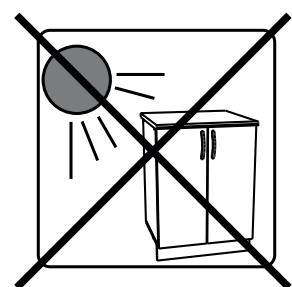
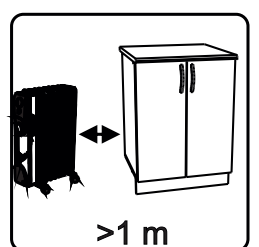
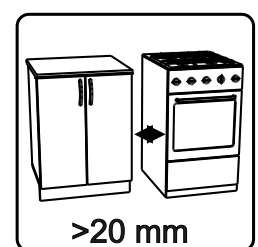
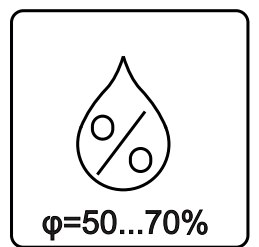
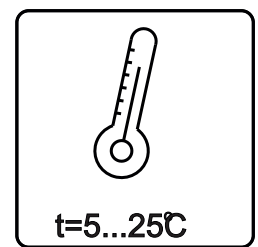
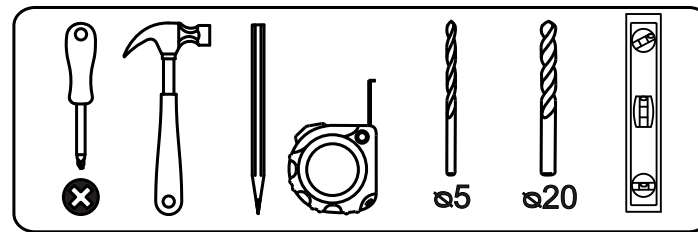
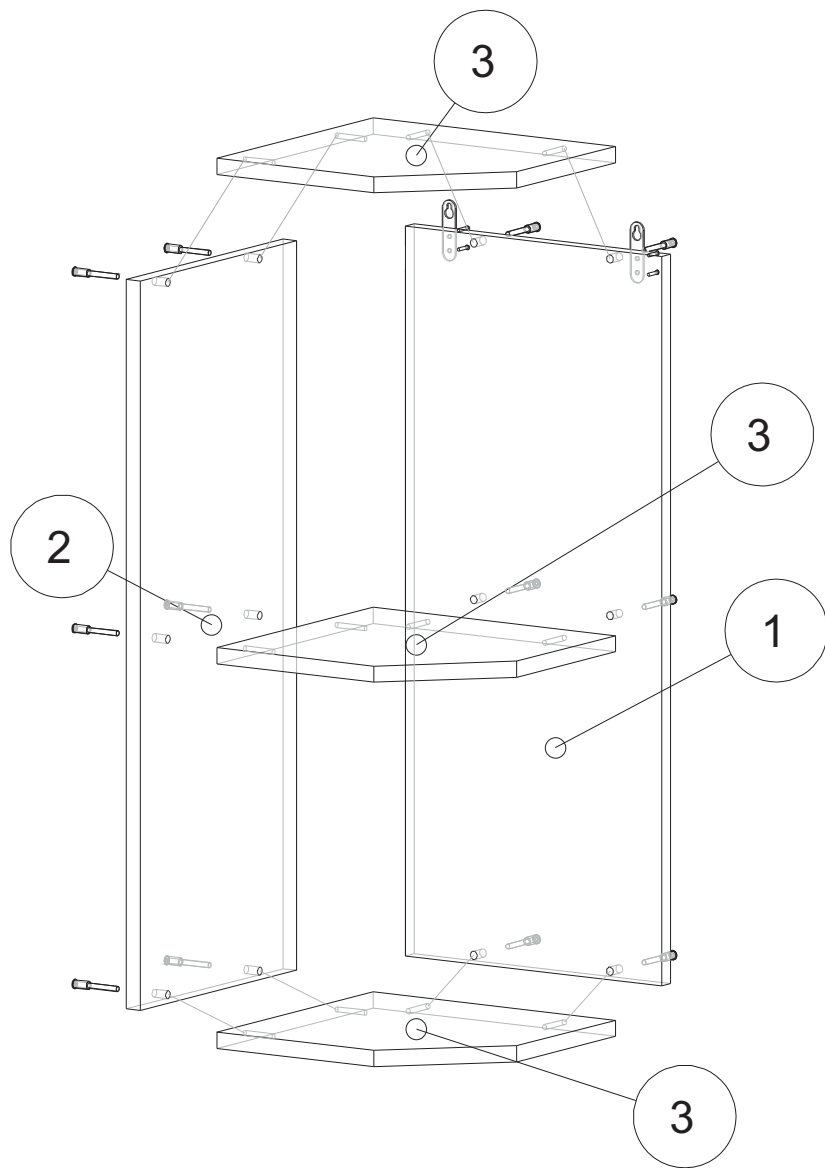

Вид	Наименование	Кол.
	Евроключ	1
	Еврошуруп 6x50	12
	Навес плоский	2
	Шуруп оцинк 4*16	4
	Еврозаглушка белая	12
	Стяжка межсекц	2

Спецификация на ЛДСП БЕЛЫЙ 16

Поз.	Наименование	Кол-во	Длина	Ширина
1	Задняя стенка	1	720	300
2	Бок	1	720	272
3	Вязка	3	284	272

1

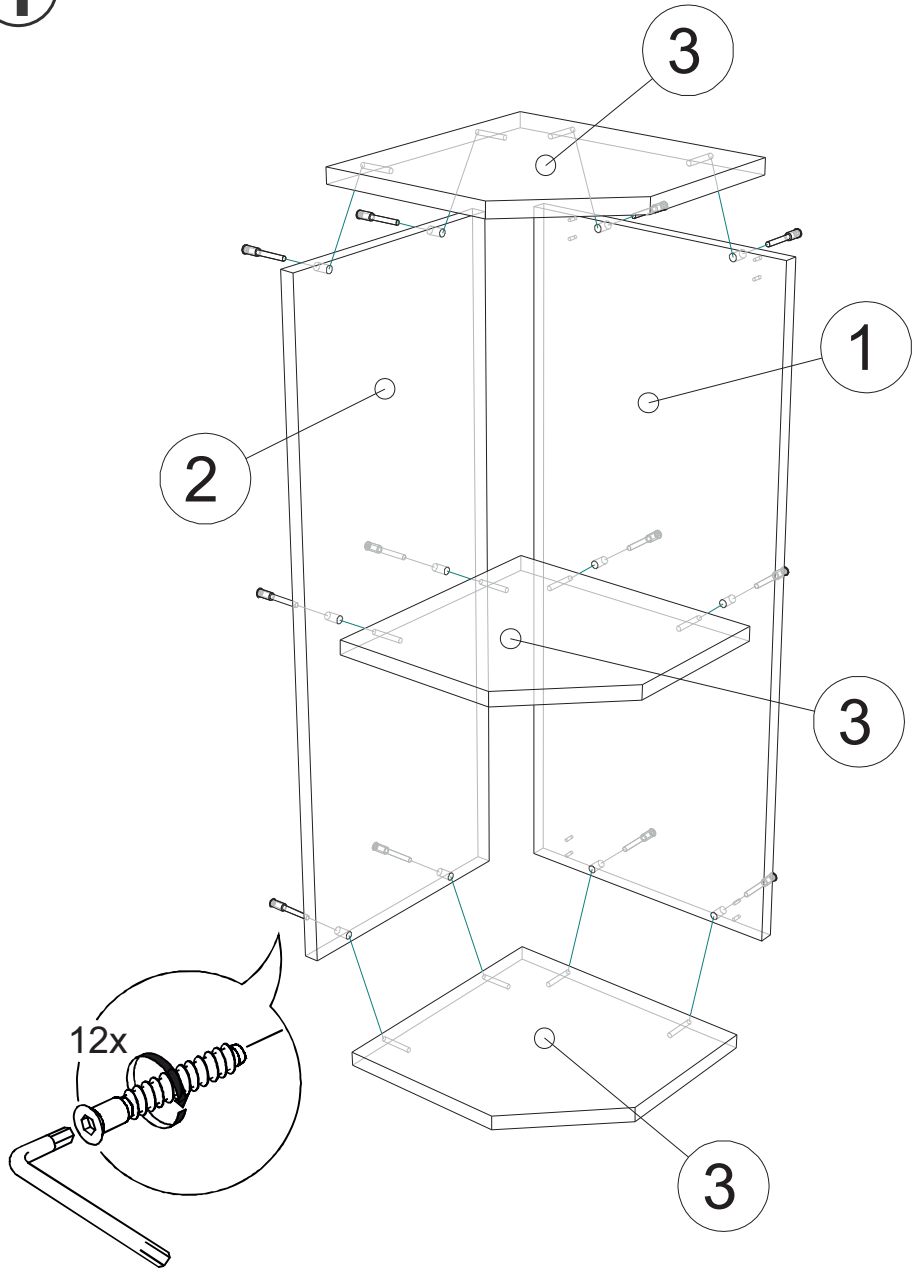

2

